

***MOTIVI  
DECORATIVI  
IN FERRO BATTUTO***

**“Policarbonato”**

***ACCESSORI VARI***

***SERRATURE  
DISCHI PER MOLA  
ACCESSORI PER PONTEGGI  
CURVE  
CERNIERE***

# FERRO BATTUTO - motivi decorativi



Art. 48/B/1  
 Ø 12 x 12 mm  
 55 x 900 mm



Art. 48/B/2  
 Ø 12 x 12 mm  
 55 x 900 mm



Art. 52/E/1  
 Ø 12 x 12 mm  
 180 x 900 mm



Art. 52/F/1  
 Ø 12 x 12 mm  
 260 x 900 mm



Art. 64/F/1  
 Ø 25 x 25 mm  
 H. 1200 mm



Art. 64/F/3  
 Ø 14 x 14 mm  
 H. 900 mm



Art. 64/F/5  
 Ø 14 x 14 mm  
 H. 900 mm



Art. 64/F/9  
 Ø 14 x 14 mm  
 110 x 900 mm



Art. 64/G/2  
 Ø 14 x 14 mm  
 225 x 900 mm



Art. 64/H/8  
 Ø 14 x 14 mm  
 225 x 900 mm



Art. 64/H/10  
 Ø 14 x 14 mm  
 30 x 900 mm

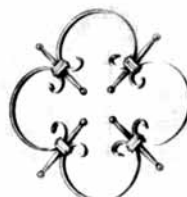
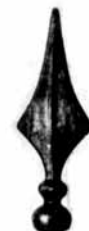

Art. 134/F/8  
 Ø 12 x 12 mm  
 235 x 900 mm

Art. 42/A/2  
∅ 16 mmArt. 42/A/6  
∅ 16 x 16 mmArt. 146/1  
∅ 40 x 830 mmArt. 144/3  
∅ 30 x 850 mmArt. 145/3  
∅ 40 x 1000 mmArt. 52/A/3  
∅ 12 x 12 mm  
170 x 900H mmArt. 52/A/5  
∅ 12 x 12 mm  
170 x 900H mmArt. 111/2  
H=900 mm ca.  
∅ 39 mmArt. 111/3  
∅ 30 x 30 mm  
H=1200 mm  
∅ 70 mmArt. 118/A/2  
∅ 14 x 14 mmBARE DI L. 3000 mm  
BARS 3000 mm LONGArt. 80/C/1  
∅ 16 x 4 mm  
110 x 270 mmArt. 80/C/2  
∅ 16 x 4 mm  
70 x 185 mmArt. 200/2  
470 x 520 mmArt. 80/B/5  
∅ 16 x 4 mm  
65 x 110 mmArt. 126/B/5  
∅ 50 mm  
85 x 165 mmArt. 158/B/7  
∅ 70 mmArt. 158/B/1  
∅ 12 x 12 mm  
55 x 130 mmArt. 80/C/4  
∅ 12 x 6 mm  
110 x 270 mmArt. 80/C/5  
∅ 12 x 6 mm  
70 x 185 mmArt. 80/B/2  
∅ 16 x 4 mm  
95 x 135 mmArt. 80/B/7  
∅ 12 x 6 mm  
95 x 135 mmArt. 126/C/9  
∅ 40 mm  
80 x 150 mmArt. 126/C/6  
∅ 23 mm  
70 x 160 mmArt. 116/F/2 ∅ 25 mm  
Art. 116/F/4 ∅ 40 mm  
Art. 116/F/7 ∅ 70 mmArt. 80/C/3  
∅ 16 x 4 mm  
65 x 155 mmArt. 114/A/4  
∅ 35 x 9 mm  
Bare di L. 2000 mm  
BARS 2000 mm longArt. 126/B/6  
∅ 20 mm  
45 x 80 mmArt. 126/B/7  
∅ 25 mm  
64 x 125 mmArt. 126/F/11  
∅ 35 x 63 mmArt. 80/C/6  
∅ 12 x 6 mm  
65 x 155 mmArt. 114/B/17  
(per corrimano Art. 114/A/4)  
(for handrail Art. 114/A/4)Art. 128/C/3  
∅ 69 mm  
H=78 mmArt. 22/3  
∅ 10 x 5 mm  
∅ 290 mmArt. 122/A/1  
∅ 35 mm  
H = 200 mmArt. 126/D/1  
∅ 18 x 18 mm  
60 x 155 mm

## ALCUNI ESEMPI DI MOTIVI DECORATIVI

Ø 300

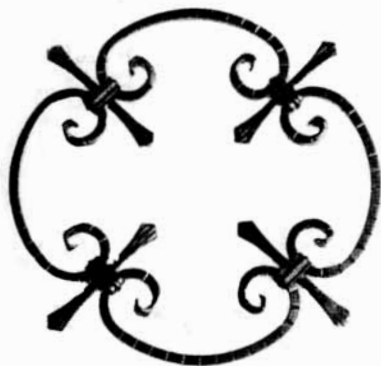

Art. 2020 ■ 8 x 8  
Art. 2021 ■ 8 x 8 fascettato

Ø 250



Art. 2015 ■ 8 x 8  
Art. 2016 ■ 8 x 8 fascettato

### STANDARD FORO A LATO 2 mt.

- Art. 7050 ● 14 INT. 14 cm.
- Art. 7051 ● 16 INT. 15 cm.
- Art. 7052 ● 18 INT. 16 cm.
- Art. 7053 ● 20 INT. 17 cm.
- Art. 7054 ● 22 INT. 17 cm.
- Art. 7055 ■ 14 INT. 14 cm.
- Art. 7056 ■ 16 INT. 15 cm.
- Art. 7057 ■ 18 INT. 16 cm.
- Art. 7058 ■ 20 INT. 17 cm.
- Art. 7059 ■ 22 INT. 17 cm.

### STANDARD FORO A LATO SPIGOLATO 2 mt.

- Art. 7060 ■ 14 INT. 14 cm.
- Art. 7061 ■ 16 INT. 15 cm.
- Art. 7062 ■ 18 INT. 16 cm.
- Art. 7063 ■ 20 INT. 17 cm.

### MISURE A RICHIESTA FORO A LATO

- Art. 7070 ● 14
- Art. 7071 ● 16
- Art. 7072 ● 18
- Art. 7073 ● 20
- Art. 7074 ● 22
- Art. 7075 ● 25
- Art. 7076 ● 30
- Art. 7080 ■ 14
- Art. 7081 ■ 16
- Art. 7082 ■ 18
- Art. 7083 ■ 20
- Art. 7084 ■ 22
- Art. 7085 ■ 25
- Art. 7086 ■ 30

### MISURE A RICHIESTA FORO DIAGONALE

- Art. 7090 ■ 14
- Art. 7091 ■ 16
- Art. 7092 ■ 18
- Art. 7093 ■ 20

### MISURE A RICHIESTA FORO IN SPIGOLO

- Art. 7095 ■ 14
- Art. 7096 ■ 16
- Art. 7097 ■ 18
- Art. 7098 ■ 20

### MISURA SU RICHIESTA FORO OVALE

- Art. 7100 ■ 14
- Art. 7101 ■ 16
- Art. 7102 ■ 18
- Art. 7103 ■ 20
- Art. 7105 ● 14
- Art. 7106 ● 16
- Art. 7107 ● 18
- Art. 7108 ● 20

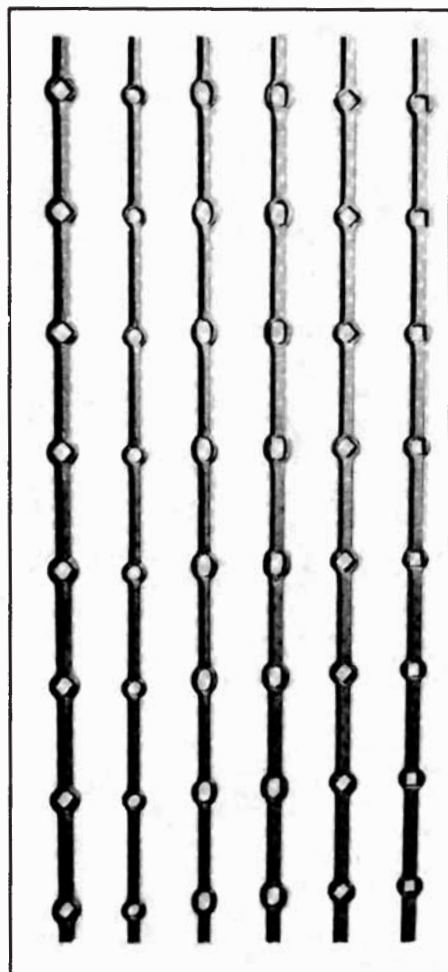

H 720 x 125



Art. 1070 ■ 16 x 4  
 Art. 1071 ■ 20 x 6

H 180 x 80

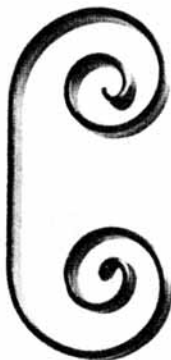

Art. 1001 ■ 16 x 4  
 Art. 1002 ■ 20 x 6  
 Art. 1003 ■ 12 x 6  
 Art. 1004 ■ 8 x 8

H 220 x 120



Art. 1030 ■ 16 x 4  
 Art. 1031 ■ 20 x 6  
 Art. 1032 ■ 12 x 6  
 Art. 1033 ■ 8 x 8

Ø 380 fascettato

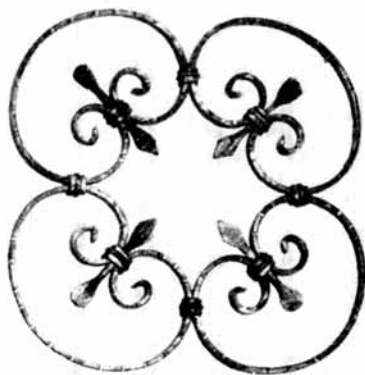

Art. 2055 ■ 12 x 6  
 rifinito a caldo

Ø 380 fascettato

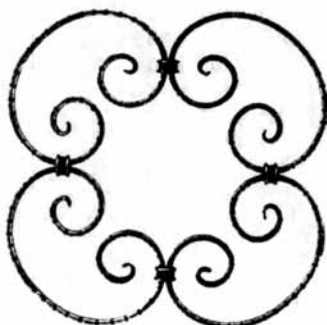

H 180



Art. 9010 base Ø 35

## MOLE ABRASIVE RINFORZATE A CENTRO DEPRESSO

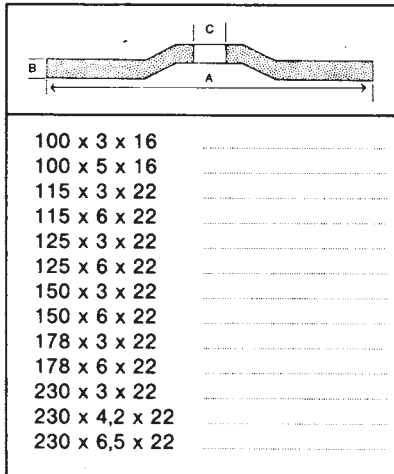

## MOLE ABRASIVE RINFORZATE PIANE DA TAGLIO

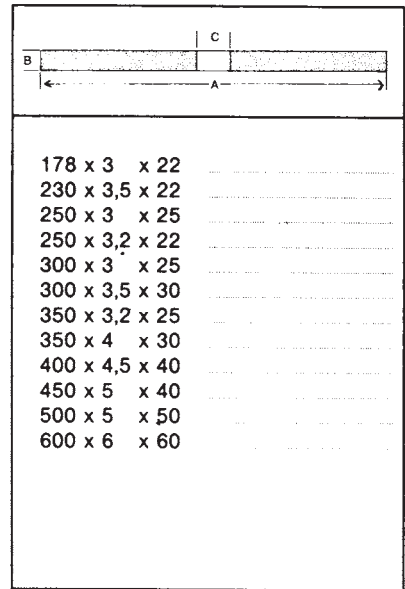

## ACCESSORI PER PONTEGGI

BASETTA

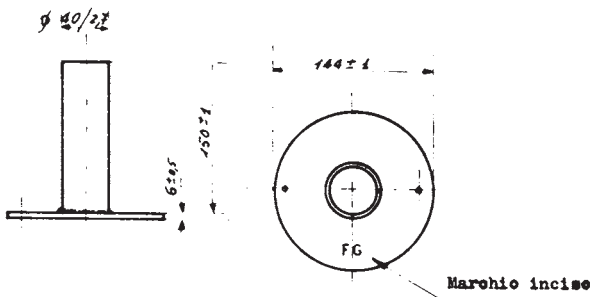

GIUNTO GIREVOLE

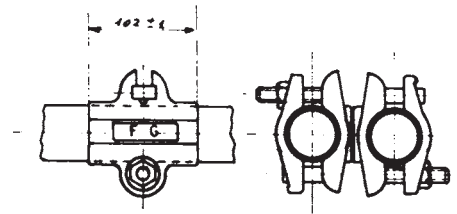

SPINOTTO

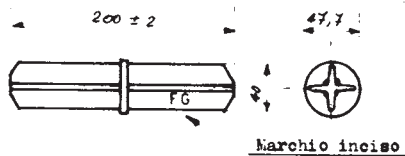

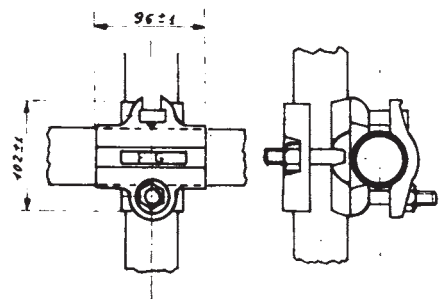

GIUNTO ORTOGONALE



# CERNIERE

IN ACCIAIO, STAMPATE A 2 e 3 ALI

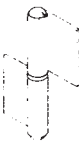
DISEGNO	CODICE ARTICOLO	DESCRIZIONE							
		ALTEZZA mm	60	80	100	120	140	170	200
	<b>KOSMO 1200</b> cerniera in acciaio stampato a 2 ali corte Perno fisso	Ø PERNO mm	8	8	9	10	11	12	14
		PREZZO LISTINO	<b>690</b>	<b>800</b>	<b>910</b>	<b>1.130</b>	<b>1.390</b>	<b>2.790</b>	<b>3.540</b>
		CONFEZIONE STANDARD	576	240	168	120	96	72	60
			<b>HORA 1300</b> cerniera in acciaio stampato a 2 ali corte Perno sfilabile	ALTEZZA mm	60	80	100	120	140
Ø PERNO mm	6			8	9	10	11	12	14
PREZZO LISTINO	<b>420</b>			<b>570</b>	<b>730</b>	<b>940</b>	<b>1.250</b>	<b>2.160</b>	<b>2.530</b>
CONFEZIONE STANDARD	576			240	168	120	96	72	60
	<b>MERIDIANA 1400</b> cerniera in acciaio stampato a 3 ali corte Perno sfilabile	ALTEZZA mm	80	100	120	140	170	200	
		Ø PERNO mm	8	9	10	11	12	14	
		PREZZO LISTINO	<b>680</b>	<b>840</b>	<b>1.090</b>	<b>1.310</b>	<b>2.370</b>	<b>2.950</b>	
		CONFEZIONE STANDARD	240	168	120	96	72	60	
	<b>FISCIA 1500</b> S D in acciaio piegato a 2 ali medie destra/sinistra Perno fisso	ALTEZZA mm	60	80	100	120	140	160	
		Ø PERNO mm	8,5	8,5	10,5	10,5	12	12	
		ALA mm	18	18	33	33	35	35	
		PREZZO LISTINO	<b>910</b>	<b>1.040</b>	<b>1.510</b>	<b>1.770</b>	<b>2.420</b>	<b>2.890</b>	
		CONFEZIONE STANDARD	160	120	64	64	64	64	

### Curve saldate DIMA 3 D - Serie normale

Diametro		Spes- sore s mm	Dimensioni nominali					Peso	
Nominale DN	Esterno mm		r mm	b mm	2b mm	c mm	90° Kg	180° Kg	
20	<b>26.9</b>	<b>2.3</b>	29	43	86	58	0.06	0.1	
25	<b>33.7</b>	<b>2.6</b>	38	56	112	76	0.12	0.2	
32	<b>42.4</b>	<b>2.6</b>	48	69	138	96	0.19	0.3	
40	<b>48.3</b>	<b>2.6</b>	57	82	164	114	0.26	0.5	
50	<b>60.3</b>	<b>2.9</b>	76	106	212	152	0.49	0.9	
65	<b>76.1</b>	<b>2.9</b>	95	133	266	190	0.78	1.5	
80	<b>88.9</b>	<b>3.2</b>	114	159	318	228	1.22	2.4	
-	<b>101.6</b>	<b>3.6</b>	134	184	368	267	1.83	3.6	
-	<b>108.0</b>	<b>3.6</b>	143	196	392	285	2.08	4.1	
100	<b>114.3</b>	<b>3.6</b>	152	210	420	304	2.36	4.7	
-	<b>133.0</b>	<b>4.0</b>	181	247	494	362	3.62	7.2	
125	<b>138.7</b>	<b>4.0</b>	190	260	520	380	4.00	8.0	
-	<b>158.0</b>	<b>4.5</b>	216	294	588	432	5.80	11.60	
150	<b>168.3</b>	<b>4.5</b>	229	313	626	457	6.50	13.00	
-	<b>193.7</b>	<b>5.0</b>	270	367	734	540	11.00	22.00	
200	<b>219.1</b>	<b>5.5</b>	305	414	818	610	15.80	31.60	
250	<b>273.0</b>	<b>6.3</b>	381	518	1036	762	24.80	59.60	
300	<b>323.9</b>	<b>7.1</b>	457	619	1238	914	39.80	79.60	

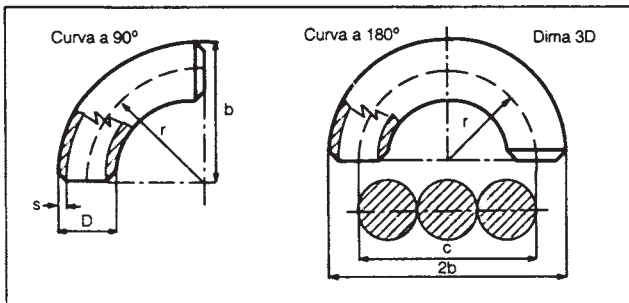

**PRODOTTI ALVEOLARI - STANDARD E TOLLERANZE**

<b>SPESSORE/TIPO</b> -/+ 0,5 (mm)	4/2		6/C	8/2		10/3		16 XP	25 XP	32 XX	40
<b>SEZIONE PASSO</b> -/+ 0,5 (mm)	 5,8	 5,8	 177/51	 11	 11	 20	 20	 25	 25	 32 XX	 40
<b>PESO</b> -/+ 3% (gr / m <sup>2</sup> )	800	1.300	2.000 2.500	1.500	1.700	2.000	2.700	2.500	3.500	3.800	4.000
<b>LARGHEZZA</b> -0/+ 10 (mm)	2.100 1.220	2.100 1.220	1.097 920	2.100	2.100	2.100	2.100 1.220	2.100 1.220	1.220	1.230	515
<b>LUNGHEZZA</b> -0/+ 20 (mm)	6.000	6.000	6.000	6.000	6.000	6.000	6.000	6.000	6.000	6.000	6.000
<b>NASTRI ANTIPOLVERE</b> (colore)	-	bianco	-	rosso	giallo	arancio	azzurro	viola	marrone	bordeaux	trasp.

• Tutti i prodotti sono disponibili in versione protetta U.V. e, su richiesta, anche in versione non protetta U.V.

**PROFILI IN POLICARBONATO (NORMALI E PROTETTI UV).**

Sono disponibili profili di congiunzione piana tra le lastre (profili H) e di chiusura inferiore alveoli (profili U) sono estrusi in polycarbonato **makrolon®** Bayer, nei diversi spessori ed in lunghezza standard. I profili H sono coestrusi per avere una protezione dalla radiazione UV.

Giunzioni ad H - Lunghezza standard 6 metri

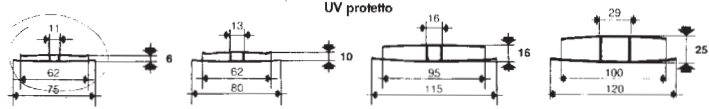

Chiusure a U - Lunghezza standard 2,15 metri

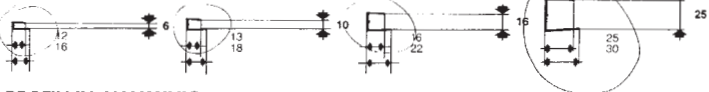

**PROFILI IN ALLUMINIO**

I profili di alluminio illustrati sono disponibili in lunghezze da 6 metri ed in versione "grezzo" o "anodizzato argento".

